



# SLIDE

Aménagement  
& Décoration d'événements  
Location de mobiliers



[www.trends.co.ma](http://www.trends.co.ma) [info@trends.co.ma](mailto:info@trends.co.ma) Tél.: 05 22 25 10 70



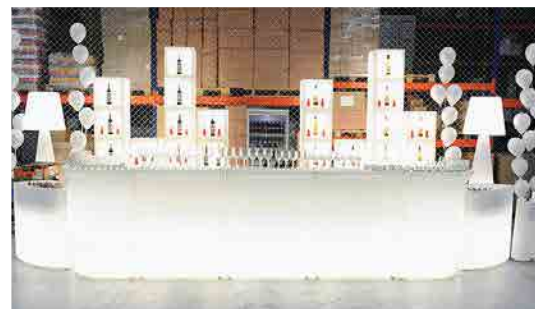
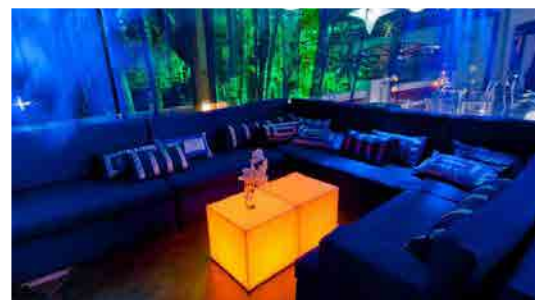

Créez l'émotion,  
osez par le design,  
illuminez votre marque.

Trends & Co met son savoir-faire en action pour fournir des solutions clés en main, innovantes et compétitives, dédiées aux marques et aux professionnels de l'événementiel pour l'exécution des projets les plus inventifs.

Le design de la gamme italienne Slide® est au centre de nos solutions d'agencement des événements, procurant aux marques un avantage différenciateur pour activer et partager leur rayonnement avec leurs publics.

Mobiliers lumineux et colorés, au design épuré et parfois ironique, les produits Slide® sont réalisés en polyéthylène par roto-moulage et caractérisés par une utilisation exceptionnelle de la lumière. Ils sont idéals pour des agencements extérieurs, intérieurs et pour l'événementiel. Ce sont le résultat de collaborations avec des designers de renommée internationale comme Karim Rashid, Marcel Wanders, Paola Navone, Marc Sadler, Alessandro Mendini, Stefano Giovannoni et Denis Santachiara, répondant à la volonté de créer un produit de qualité.

Fascinez par la lumière et la couleur, créez l'émotion !

**Counters**  
**Tables**  
**Lamps**  
**Geoline**  
**Seats**  
**Pots**  
**Complements**  
**Design of Love**



COUNTERS

SLIDE®

# BREAK BAR

Design Slide Studio

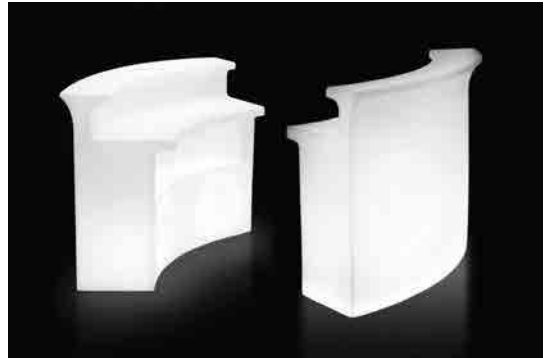

173



110

75

**LP BRB110**  
lighting

173W / 75D / 110H cm  
polyethylene

45 Kg LA light white



BULB : 2 X 25W - E27 5

1,487m<sup>3</sup>

**SLIDE**®

[www.trends.co.ma](http://www.trends.co.ma)

**ICE BAR**  
Design Slide Studio

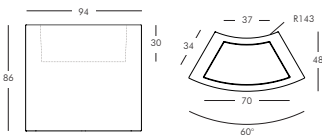
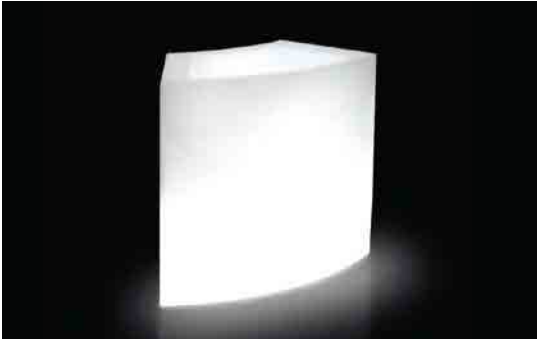

**SD ICB065** lighting 94 x 48 h 86 cm 18 Kg LA light white polyethylene



0,507m<sup>3</sup>  
3

**SLIDE®**

www.trends.co.ma

# SNACK BAR

Design Slide Studio

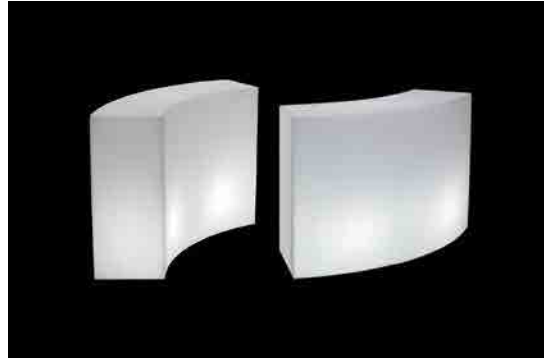

**SD SNB100**  
lighting

165W / 600 / 100H cm  
polyethylene

30 Kg LA light white



1,04 m<sup>3</sup>  
4

**SLIDE®**

[www.trends.co.ma](http://www.trends.co.ma)

**MYDESK**  
Design Slide Studio

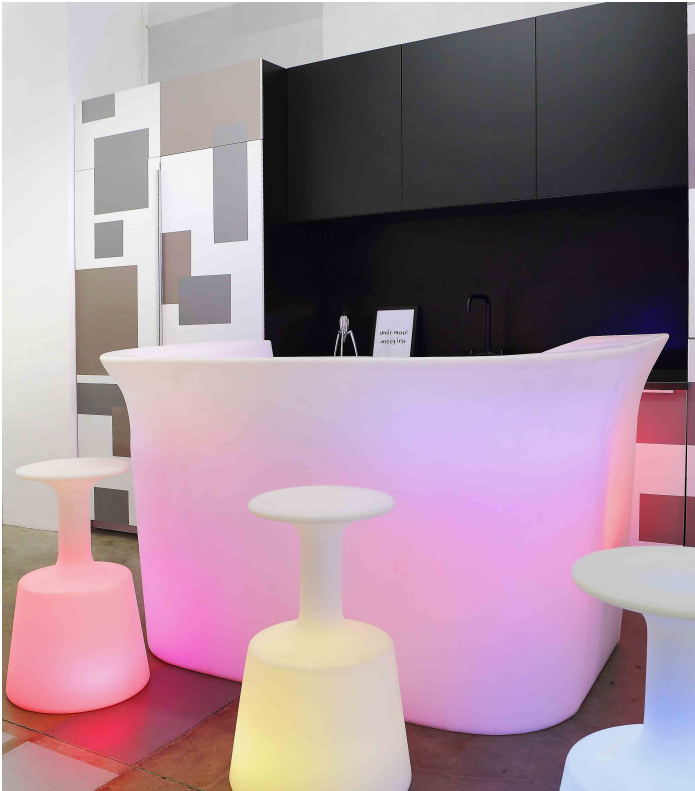
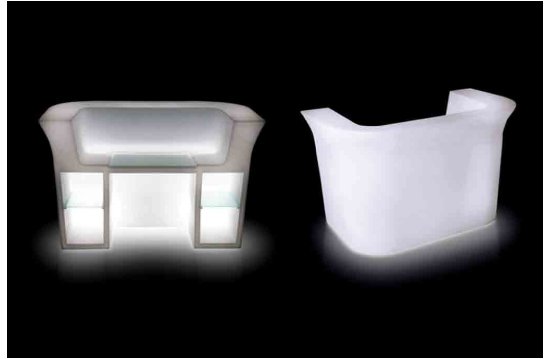

**MYDESK**  
design SLIDE Studio



**SD DES110** 180 / 100 / 110 64 **LA** light white  
lighting  
polyethylene,  
tempered glass  
top and shelves  
(included)



**LA** 182 / 102 / 113  
2,097  
75  
1

**SLIDE**<sup>®</sup>

www.trends.co.ma



## JUMBO BAR

Design Jorge Najera

## JUMBO CORNER

Design Jorge Najera

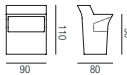
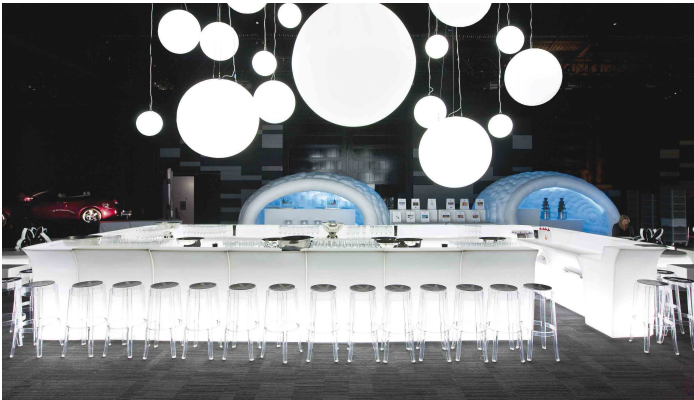
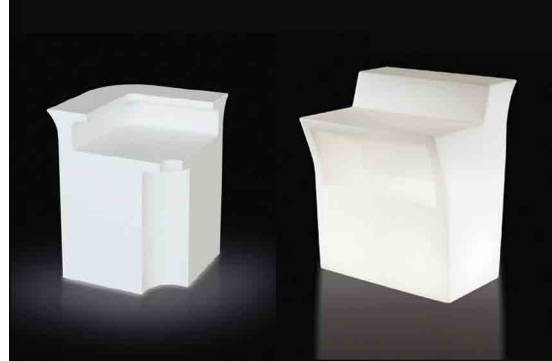

**LP BAR110**  
lighting

90W / 80D / 110H cm  
polyethylene

27 Kg

LA light white



0,882 m<sup>3</sup>  
7

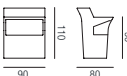

**LP BAR111**  
lighting

85W / 85D / 110H cm  
polyethylene

27 Kg

LA light white



0,882 m<sup>3</sup>  
4

**SLIDE**®

[www.trends.co.ma](http://www.trends.co.ma)

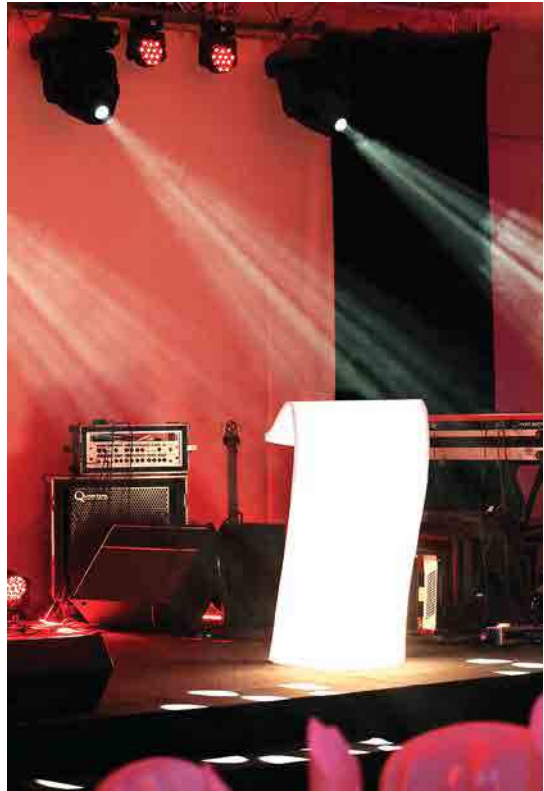

**SD SWS110** 62W / 62D / 120H cm 16 Kg STANDARD COLOURS 0,902 m<sup>3</sup>  
standard polyethylene 2

**SLIDE**®

[www.trends.co.ma](http://www.trends.co.ma)

**PEAK**  
Design Aksu, Suardi



LP PEA121  
lighting

Ø 80 / 120 cm  
polyethylene,  
tempered glass  
(included)

18 Kg

LA light white



0,086 m<sup>3</sup>  
15

**SLIDE**®

www.trends.co.ma

# AMÈLIE UP

design Italo Pertichini



**LP AUP110**  
lighting

Ø 61,5 / 110 cm  
polyethylene

8 Kg

LA light white



0,488 m<sup>2</sup>  
20

**SLIDE®**

[www.trends.co.ma](http://www.trends.co.ma)



# TABLES

SLIDE®

# KUBO

Design Slide Studio

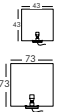
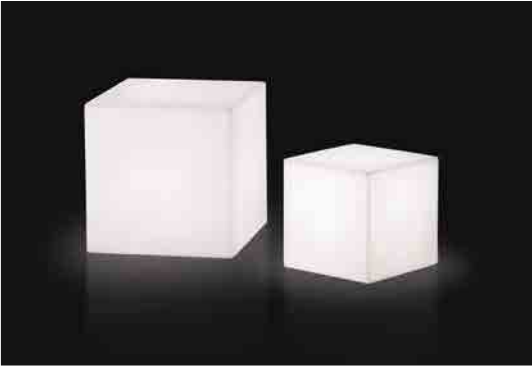

**CUBO 40** LP CUB042 lighting IN

43W / 43D / 43H cm polyethylene

4,1 Kg LA light white (MATT FINISH)



0,099 m<sup>3</sup>  
34



**CUBO 75** LP CUB076 lighting IN

73W / 73D / 73H cm polyethylene

20 Kg LA light white (MATT FINISH)



0,531 m<sup>3</sup>  
16

**SLIDE**®

www.trends.co.ma

**ARTHUR**  
Design Slide Studio



**SD ART130**  
lighting

Ø 120 / 72 cm  
polyethylene,  
tempered glass  
top (included)

43 Kg

LA light white



0,834 m<sup>3</sup>  
10

**SLIDE**®

www.trends.co.ma

# SQUARE

Design Slide Studio



**SD SQR075** 150W / 150D / 74H cm 88 Kg **LA** light white  
lighting polyethylene, tempered glass top (included)

0,576 m<sup>3</sup>  
BULB: 1 X **60W** - E27  
9

**SLIDE**®

www.trends.co.ma



**TAO**  
Design Guglielmo  
Berchicci

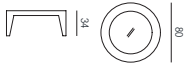

**SD TAO080**  
standard

Ø 80 / 34 cm  
polyethylene,  
tempered glass  
top (included)

12 Kg

STANDARD COLOURS



0,341 m<sup>3</sup>  
7

**SLIDE**®

www.trends.co.ma

# BLOS LOW TABLE

Design Karim Rashid



SD BLT032  
standard

55 x 42 x 32h cm  
polyethylene

4,5 Kg

STANDARD COLOURS



0,079 m<sup>3</sup>  
10

SLIDE®

[www.trends.co.ma](http://www.trends.co.ma)

**MINI  
SQUARE**  
Design Slide Studio

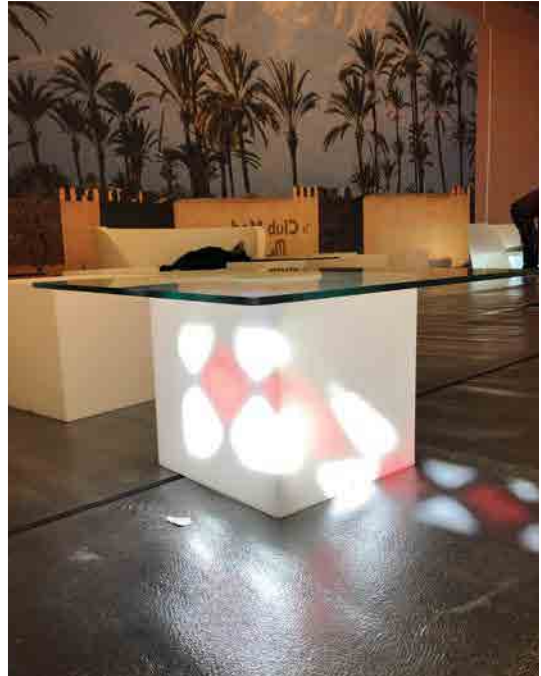
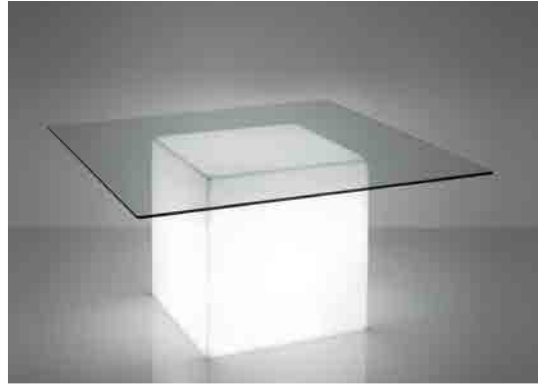

**SD SQR045**  
lighting

80W / 80D/ 45H cm  
polyethylene,  
tempered glass  
top (included)

20 Kg **LA** light white



0,576 m<sup>3</sup>  
10  
BULB: 1 x **GSW** - E27

**SLIDE**®

www.trends.co.ma



# LAMPS

SLIDE®

**SIRIO**  
Design Slide Studio

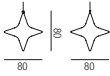

**SD ETF080** 80W / 80D / 80H cm 4,5 Kg  
lighting OUT polyethylene

**LA** light white, **LD** light red,  
**LU** light fuchsia

 0,19 m<sup>3</sup>  
BULB : 1 X 15W - E27 6

**SLIDE**®

[www.trends.co.ma](http://www.trends.co.ma)



GEOLINE

SLIDE®

# GLOBO

Design Slide Studio



	<p><b>LP SFF042</b> lighting OUT</p>	<p>Ø 40 cm polyethylene</p>	<p>2 Kg</p>	<p>LA light white</p>		<p>0,069 m<sup>3</sup> 10 BULB : 1 X 25W - E27</p>
	<p><b>LP SFF062</b> lighting OUT</p>	<p>Ø 40 cm polyethylene</p>	<p>6 Kg</p>	<p>LA light white</p>		<p>0,069 m<sup>3</sup> 6 BULB : 1 X 25W - E27</p>
	<p><b>LP SFF082</b> lighting OUT</p>	<p>Ø 40 cm polyethylene</p>	<p>8 Kg</p>	<p>LA light white</p>		<p>0,069 m<sup>3</sup> 4 BULB : 1 X 25W - E27</p>

**CONO**  
Design Slide Studio

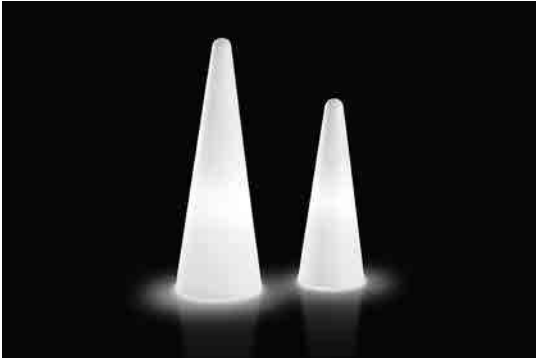

**LP COF113**  
lighting OUT

Ø 42 / 113 cm  
polyethylene

6 Kg

LA light white (MATT FINISH)

**E3** (FLUO) (GREEN LIGHT)  
BULB : 1 X 25W - E27

6



**LP COF150**  
lighting OUT

Ø 53 / 150 cm  
polyethylene

13 Kg

LA light white (MATT FINISH)

**E3** (FLUO) (GREEN LIGHT)  
BULB : 1 X 25W - E27

6

**SLIDE**®

www.trends.co.ma



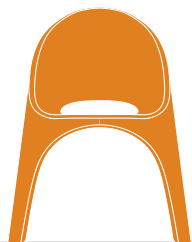

SEATS



SLIDE®

# SNAKE

Design Slide Studio



SD SNF120  
lighting OUT

123W / 53D / 43H cm  
polyethylene

11 Kg

LA light white



0,287 m<sup>3</sup>  
26

SLIDE®

www.trends.co.ma

**YPSILON**  
Design Slide Studio



**SD YPF120** 100W / 117D / 43H cm 15 Kg LA light white 0,551 m<sup>3</sup>  
lighting OUT polyethylene



7

**SLIDE**®

www.trends.co.ma

# KONCORD

Design Karim Rashid



**SD KON075**  
standard

43W / 40D / 76H cm  
polyethylene 5 Kg

STANDARD COLOURS,  
- FT milky white 10  
- FT jet black 10  
- FT flame red 10



0,161 m<sup>3</sup>

**SLIDE**®

[www.trends.co.ma](http://www.trends.co.ma)

**RAP**  
Design Karim Rashid



**LP RAP075** 170W / 80D / 75H cm 35 Kg LA light white,  
lighting seat H 36  
polyethylene



1,086 m<sup>3</sup>  
16  
FLUO  
100W  
BULB : 2 X 25W - E27

**SLIDE**®

www.trends.co.ma

# RAP CHAIR

Design Karim Rashid



**SD RAC075** 115 x 78 x 75h cm 24 Kg **LA** light white,  
lighting polyethylene



0,79 m<sup>3</sup>  
6

**SLIDE**®

[www.trends.co.ma](http://www.trends.co.ma)

# GLORIA

Design Marc Sadler



**SD GLR080**  
standard

56W / 54D / 80H cm  
seat H 48 polypropylene,  
steel chassis.

6 Kg

**RT** white, **RH** black,  
**RE** moka, **RC** orange



0,296 m<sup>3</sup>  
86

**SLIDE**®

[www.trends.co.ma](http://www.trends.co.ma)

# BEAN BAG



Taille 180 cm x 20    Taille 140 cm x 20

**SLIDE**®

[www.trends.co.ma](http://www.trends.co.ma)



# COMPLEMENTS

An orange silhouette of a person standing on the word 'COMPLEMENTS'. The person is holding a tablet or book. To their left, there is a stack of four books. The word 'COMPLEMENTS' is rendered in a large, light gray, sans-serif font. The entire scene is reflected on a light gray surface below.

SLIDE®

**CITY**  
Design Moro, Pigatti

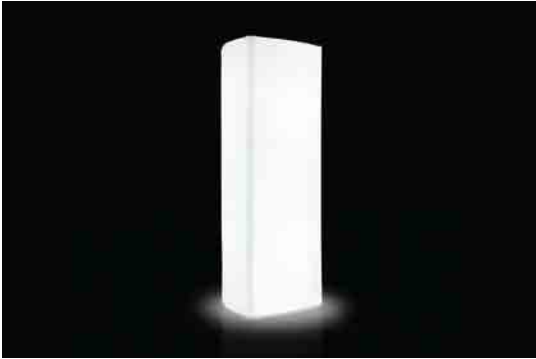

**SD CIT200**  
lighting 80W / 76D / 200H cm 27 Kg LA light white  
polyethylene



1,318 m<sup>3</sup>  
5  
BULB: 2 X 26W - E27

**SLIDE**®

www.trends.co.ma

# LIGHT DRINK

Design Jorge Najera

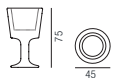

SD DRL075  
lighting

Ø 45 / 75 cm  
polyethylene

7 Kg

LA light white



BULB : 1 X 15W - E27

0,16 m<sup>3</sup>  
7

SLIDE®

[www.trends.co.ma](http://www.trends.co.ma)

# KALIMERA

Design Slide Studio



**SD KAL040**  
standard 0 44 / 40 cm 3 Kg LA Light White

polyethylene



LED version with battery  
and remote control available  
in white colour.  
3W LED RGB System included.

0,10 m<sup>3</sup>  
5

**SLIDE**®

[www.trends.co.ma](http://www.trends.co.ma)



# DESIGN OF LOVE

DESIGN OF LOVE

SLIDE®

QUEEN  
OF LOVE

MIRROR  
OF LOVE

DUKE  
OF LOVE

Design Moro, Pigatti



**QUEEN OF LOVE**

**SD QUE100**

103,5W / 98D / 112,5H cm  
seat H 38 polyethylene 20 Kg STANDARD COLOURS 1,352 m<sup>3</sup>  
2



**MIRROR OF LOVE**

**SD FRS150**

162W / 130D / 162H cm 40 Kg STANDARD COLOURS 0,180 m<sup>3</sup>  
1



**DUKE OF LOVE**

**SD DUK070**

72W / 72D / 31,5H cm 10 Kg STANDARD COLOURS 0,185 m<sup>3</sup>  
1

**SLIDE**®

[www.trends.co.ma](http://www.trends.co.ma)



CONFERENCE

CONFERENCE

# LINEA

Chaise de conférence

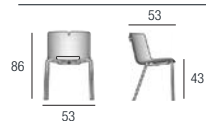
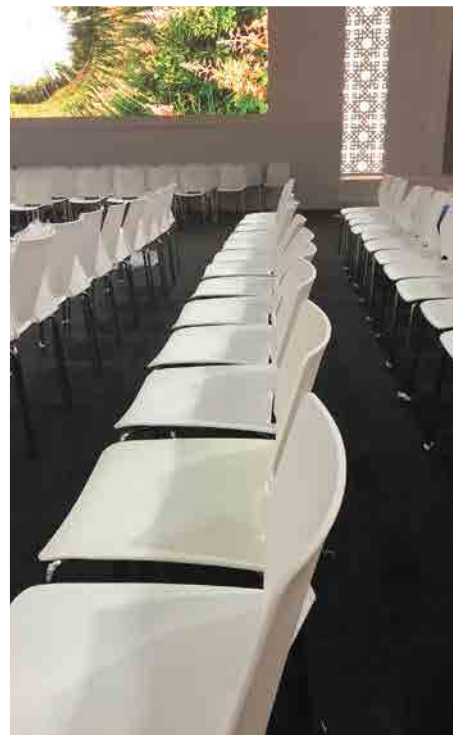

Quantité  
**320**

Dim.  
53x43xH86 cm



# TREK

Tabouret

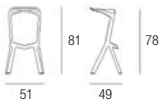

Quantité  
**320**  
Dim.  
51x49xH81cm

# GLORIA

Chaise de  
conférence

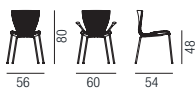

Quantité  
**86**  
Dim.  
60x54xH80cm

# MIURA

Table Haute



Quantité  
**60**  
Dim.  
60x60xH100 cm

# MIURA

Table Haute Double

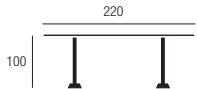

Quantité  
**30**  
Dim.  
220x70xH100 cm

# GENIUS

Bar & Desk



Quantité  
**12**  
Dim.  
250x70xH110 cm

## COMPOSITION DE BAR

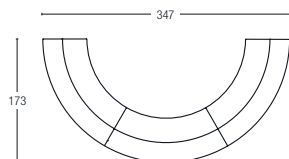
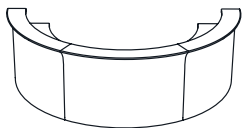

**COMPOSITION 1**  
3 x LP BRB110 Break Bar

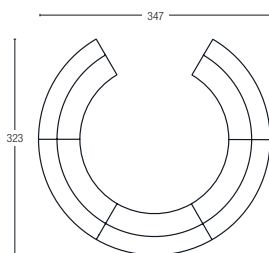
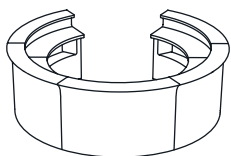
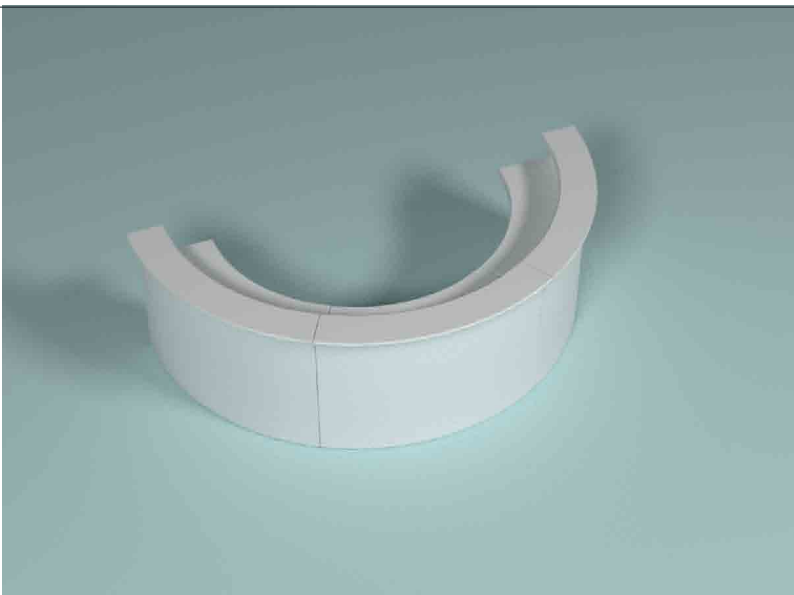

**COMPOSITION 2**  
5 x LP BRB110 Break Bar

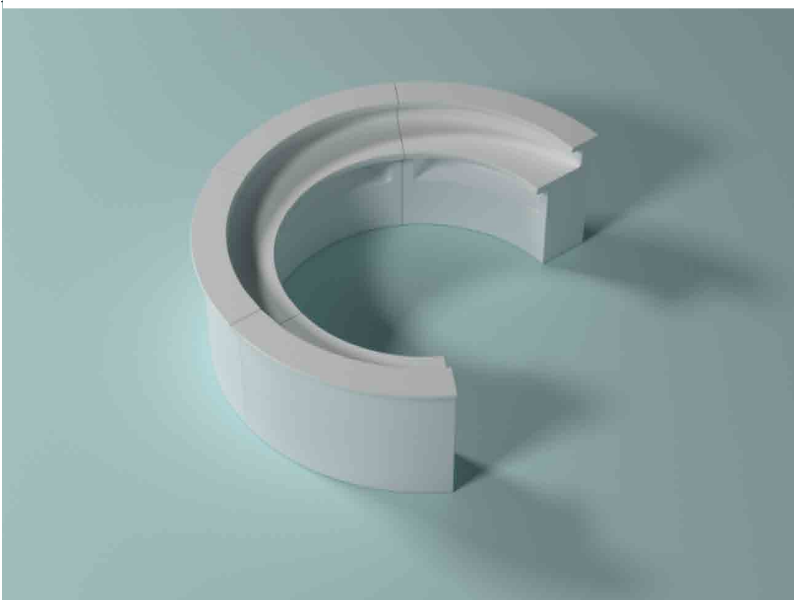

## COMPOSITION DE BAR

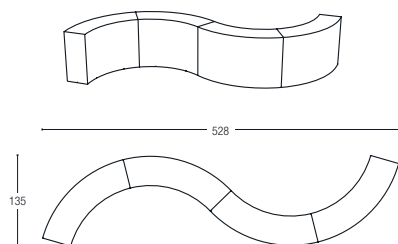

**COMPOSITION 3**  
4 x SD SNB100 Snack Bar

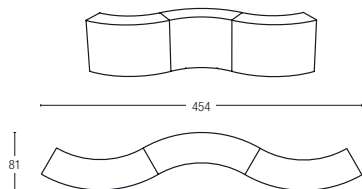
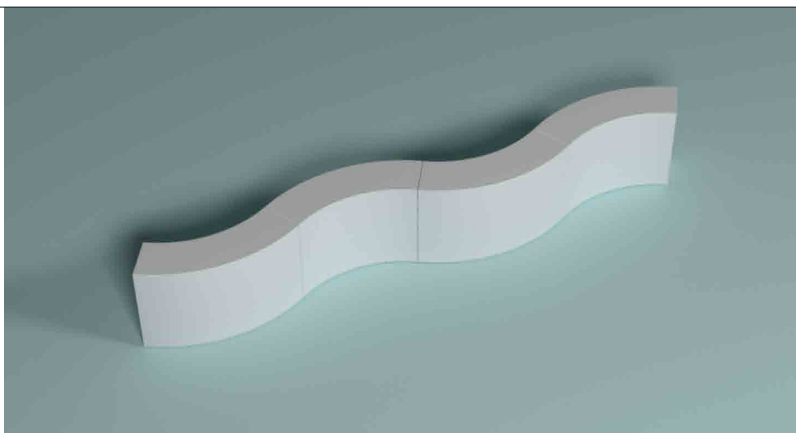

**COMPOSITION 4**  
3 x SD SNB100 Snack Bar

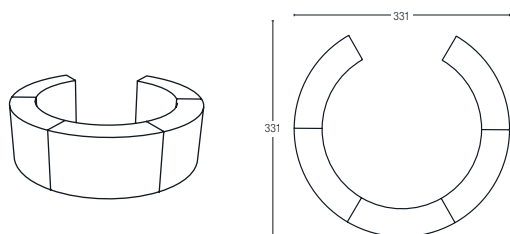
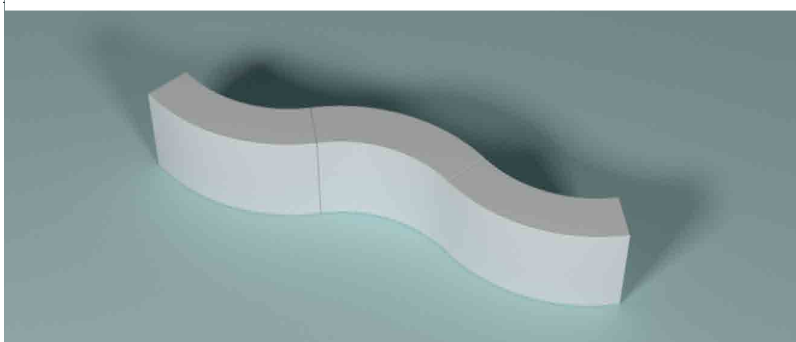

**COMPOSITION 5**  
5 x SD SNB100 Snack Bar

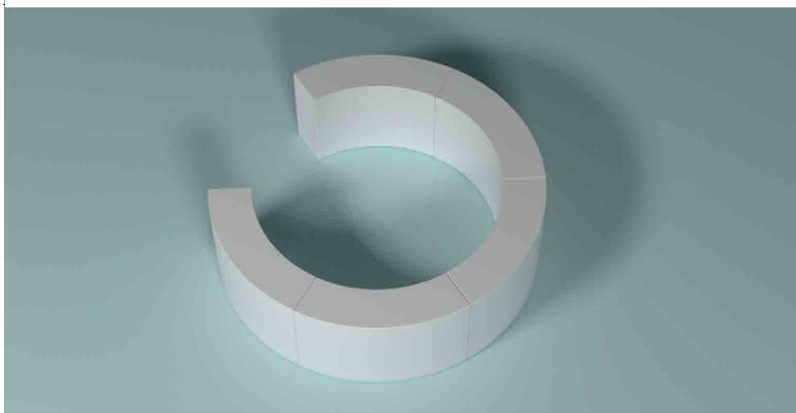

## COMPOSITION DE BAR

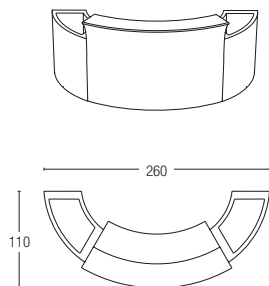

### COMPOSITION 6

1 x LP BRB110 Break Bar  
2 x SD ICB085 Ice Bar

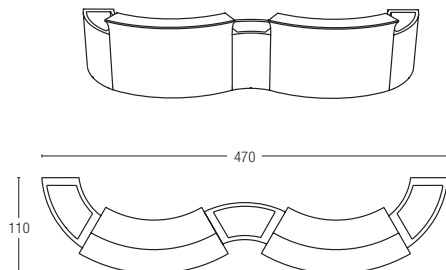
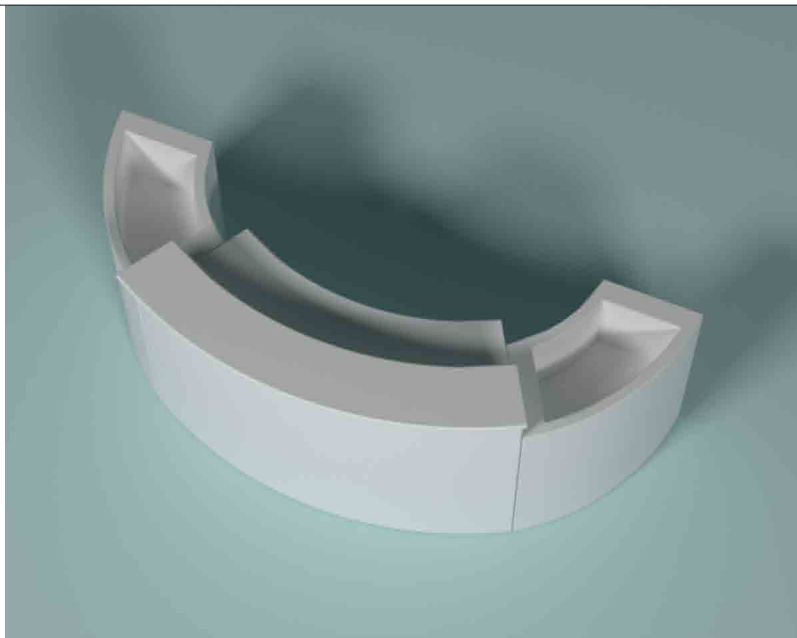

### COMPOSITION 7

2 x LP BRB110 Break Bar  
3 x SD ICB085 Ice Bar

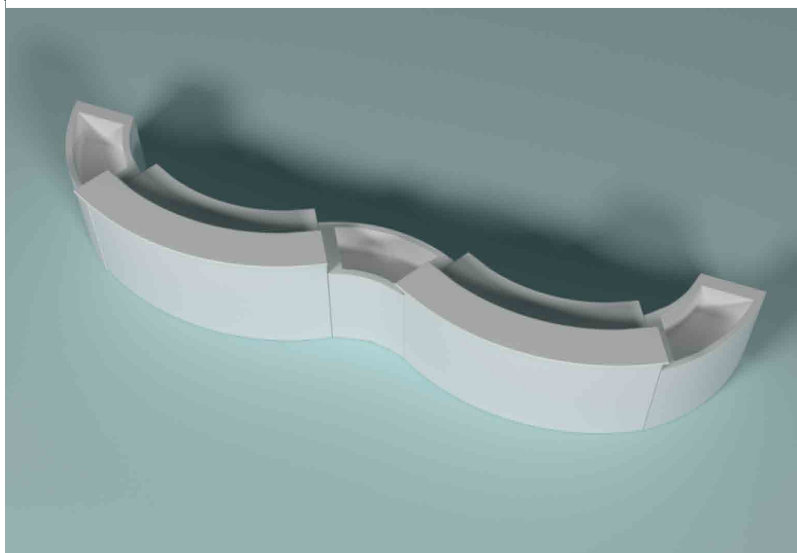



## COMPOSITION DE BAR

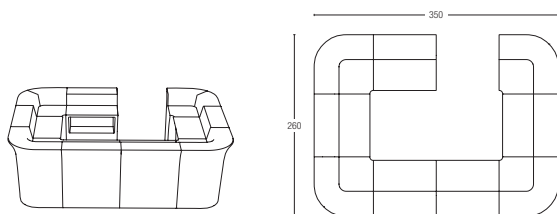

### COMPOSITION 9

5 x LP BAR110 Jumbo Bar  
4 x LP BAR111 Jumbo Corner

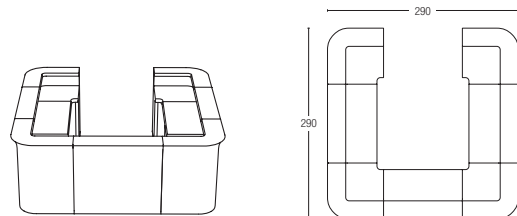
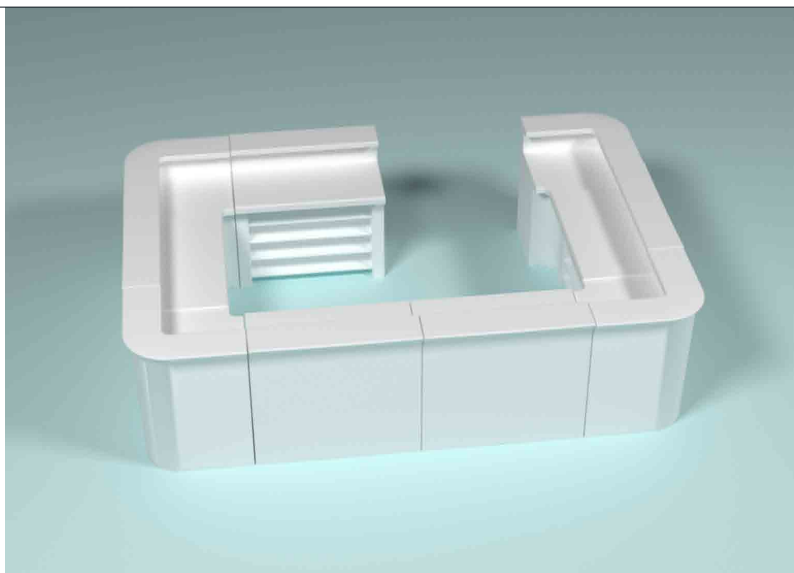

### COMPOSITION 8

4 x LP BRC110 Break Corner  
3 x LP BRD110 Break Line



## COMPOSITION D'ASSISES SERPENTINES

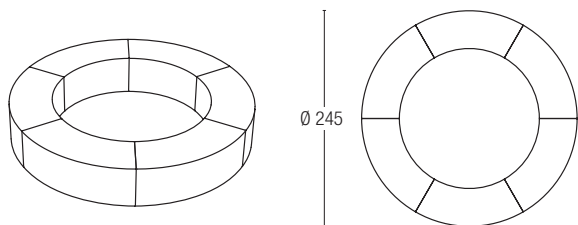

**COMPOSITION 1**  
6 x SD SNK120 Snake

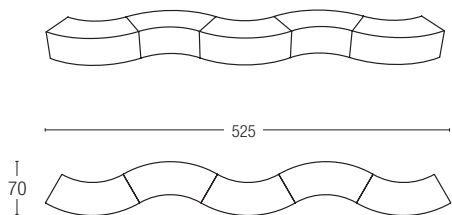
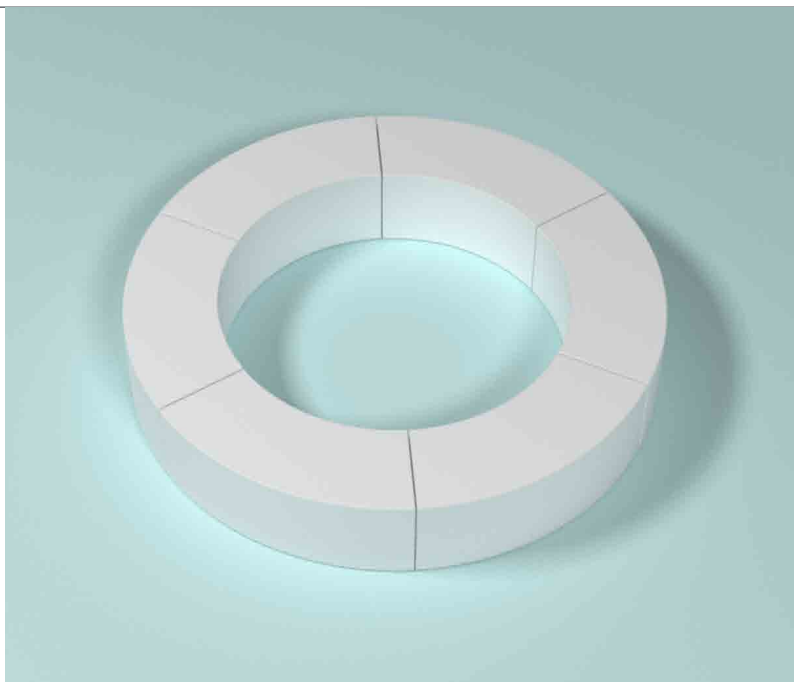

**COMPOSITION 2**  
5 x SD SNK120 Snake

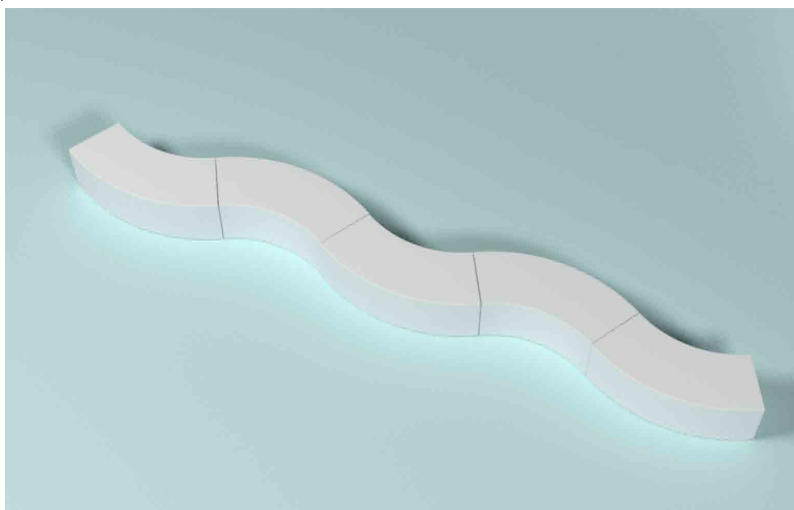

## COMPOSITION D'ASSISES SERPENTINES

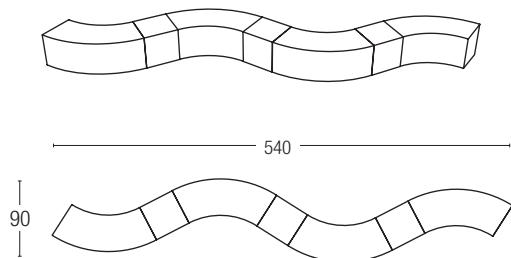

### COMPOSITION 3

4 x **SD SNK120** Snake  
3 x **LP CUB042** Cubo 40

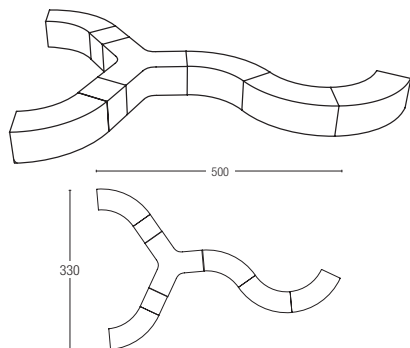
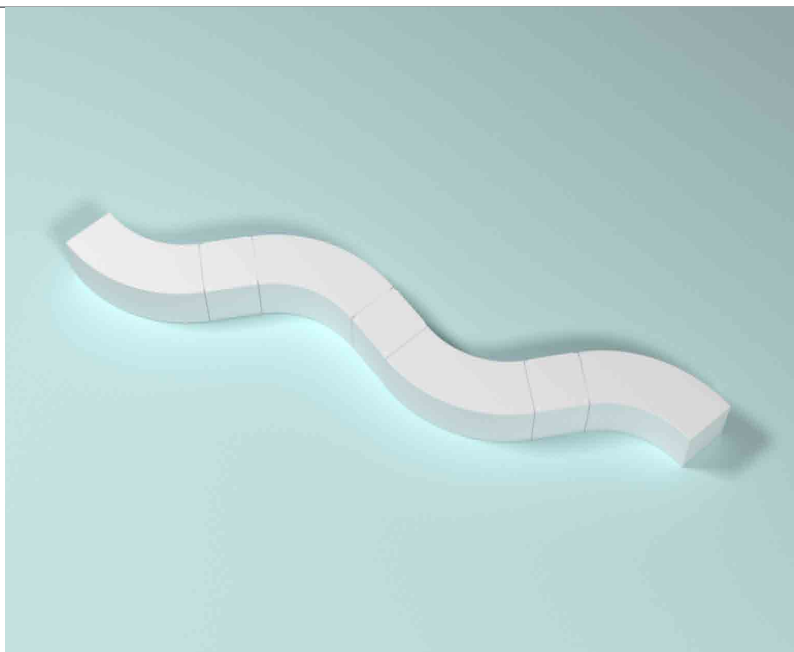

### COMPOSITION 4

5 x **SD SNK120** Snake  
2 x **LP CUB042** Cubo 40  
1 x **SD YPS120** Ypsilon

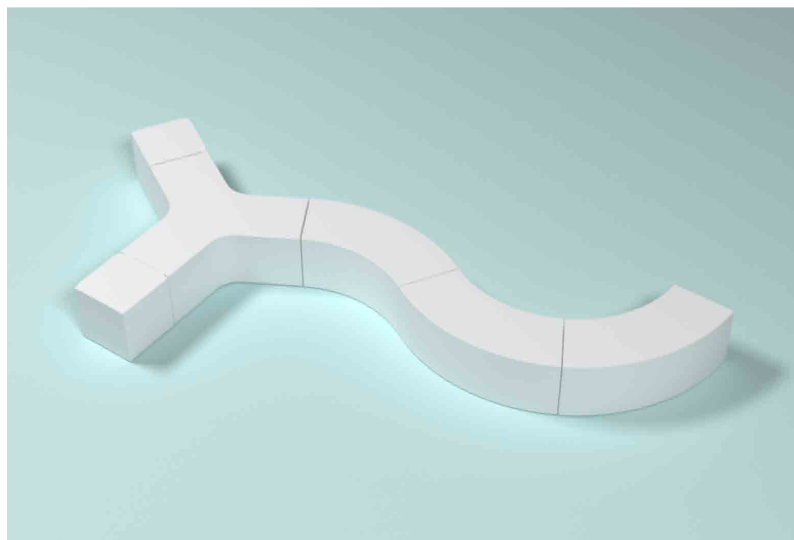



**LP BRB110  
BREAK BAR**  
172 x 75 h 110 cm  
45 Kg  
Energy saving bulb  
2 x E27 - 25W



**LP PEA120  
PEAK**  
Ø 80 h 80 / 120 cm  
Top H 110  
22 Kg  
Energy saving bulb  
1 x E27 - 25 W



**LP BRD110  
BREAK LINE**  
120 x 75 h 110 cm  
40 Kg  
Energy saving bulb  
2 x E27 - 25W



**LP CUP040  
KUBO INOX**  
43 x 43 h 43 cm  
6 Kg  
Energy saving bulb  
1 x E27 - 15 W



**SD SWS110  
SWISH**  
62 x 62 h 120 cm  
16 Kg  
Energy saving bulb  
1 x E27 - 25 W



**SD ART130  
ARTHUR**  
Ø 120 h 72 cm  
Glass top  
opal Ø 120 h 1.2 cm  
46 Kg  
Energy saving bulb  
1 x E27 - 25 W



**SD SNB100  
SD SNB102 (glass)  
SNACK BAR**  
165 x 60 h 100 cm (60°)  
30 Kg  
Energy saving bulb  
2 x E27 - 25 W



**SD ICB085  
ICE BAR**  
94 x 48 h 86 cm  
18 Kg  
Energy saving bulb  
1 x E27 - 15 W



**SD SQR075  
SQUARE**  
150 x 150 h 74 cm  
Glass top  
clear 150 x 150 h 1.2 cm  
94 Kg  
Energy saving bulb  
1 x E27 - 25 W



**LP PVT200  
PIVOT**  
Ø 60 h 200 cm  
21 Kg  
Energy saving bulb  
2 x E27 - 25 W



**SD BLT032  
BLOS LOW TABLE**  
55 x 42 x 32h cm  
4,5 Kg



**SD ETS080  
SD ETP080  
SIROIO**  
Ø 44 / 40  
6,5 Kg  
3W led system



**LB CUB050  
CUBO 50**  
Ø 145 / 48  
33,5 Kg  
3W LED SYSTEM



**LP CON113  
LP CON150  
CONO**  
Ø 42 / 113  
Ø 53 / 150  
8,5 Kg / 13 Kg  
Energy saving bulb  
1 x E27 - 25 W



**SD SNK120  
SD SNF120  
SNAKE**  
123 x 43 h 43 cm (60°)  
13,5 Kg  
Energy saving bulb  
2 x E27 - 15 W



**LP SFF042  
LP SFF062  
LP SFF082  
GLOBO 40, 60, 80**  
Ø 40, Ø 60, Ø 80  
3 Kg / 6,7 Kg / 12 Kg  
1 X 25W - E27  
1 X 25W - E27  
1 X 65W - E27



**SD RAP075  
LP RAP075 (light)  
SD RAP076 (cushion)  
RAP**  
170 x 84 h 74 cm  
Seat height 35 cm  
42,5 Kg  
Energy saving bulb  
2 x E27 - 25 W



**LP XPT100  
X-POT LIGHT**  
Ø 62 / 98  
17,5 Kg  
Energy saving bulb  
1 x E27 - 25 W



**SD CIT200  
CITY**  
80 / 76 / 200  
35 Kg  
Energy saving bulb  
2 x E27 - 25 W



**SD BAM080  
LP BAM080  
SL BAM080  
BAMBOO**  
104 x 27 x 80  
33,5 Kg  
Energy saving bulb  
2 x E27 - 15 W



**LP RAC075  
RAP CHAIR**  
115 x 78 x 75h cm  
24 Kg  
Energy saving bulb  
2 x E27 - 25 W



**SD GLR080  
GLORIA**  
56 / 54 / 80  
9 Kg



**SD KON075  
KONCORD**  
42 x 36 h 73 cm  
6,5 Kg



**SD DUK070  
DUKE OF LOVE**  
72 / 72 / 31,5  
11 Kg



**SD FRS150  
MIRROR OF LOVE**  
153 / 13 / 153  
45 Kg



**SD QUE100  
QUEEN OF LOVE**  
103,5 / 98 / 112,5  
seat H 38  
28 Kg



**LP BAR111  
LP BAR114 (glass top)  
JUMBO CORNER**  
80 x 80 h 110 cm  
27 Kg  
Energy saving bulb  
2 x E27 - 25 W



**LP BAR110  
LP BAR112 (glass shelf)  
LP BAR113 (glass top)  
JUMBO BAR**  
90 x 80 h 110 cm  
27 Kg  
Energy saving bulb  
2 x E27 - 25 W



**SD TAO080  
TAO**  
Ø 80 h 34 cm  
Glass top  
opal Ø 57,5 h 0,6 cm  
15 Kg



**LP PVG150  
PIVOT GLOBO**  
Ø 50 h 150 cm  
12 Kg  
Energy saving bulb  
2 x E27 - 25 W



**SD YPS120  
SD YPF120  
YPSILON**  
100 x 120 h 43 cm  
22,5 Kg  
Energy saving bulb  
3 x E27 - 15 W



**LP AUP110  
AMÉLIE UP**  
61,5 x 61,5 h 110 cm  
8 Kg  
Energy saving bulb  
1 x E27 - 25 W



**SD DRL075  
LIGHT DRINK**  
Ø 45 / 75  
8,5 Kg  
Energy saving bulb  
1 x E27 - 15 W



**SD KAL040  
KALIMERA**  
Ø 44 / 40  
4 Kg  
3W led system



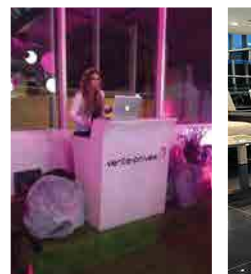



[www.trends.co.ma](http://www.trends.co.ma) [info@trends.co.ma](mailto:info@trends.co.ma) Tél.: 05 22 25 10 70

